

Instruction Manual

**BL1.5 • BL3 • BL5
BL7 • BL10
BL15 • BL20**

Dosing Pumps

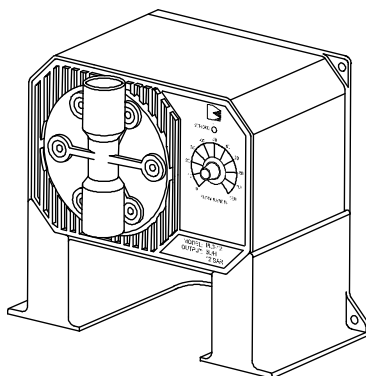

Dear Customer,
Thank you for choosing a Hanna product.
Please read this instruction manual carefully before using the pump.
If you need additional technical information, do not hesitate to e-mail us at tech@hannainst.com.
These instruments are in compliance with the **CE** directives.

WARRANTY

All Hanna Instruments **pumps are warranted for one year** against defects in workmanship and materials when used for their intended purpose and maintained according to instructions. This warranty is limited to repair or replacement free of charge. Damages due to accident, misuse, tampering or lack of prescribed maintenance are not covered. If service is required, contact the dealer from whom you purchased the instrument. If under warranty, report the model number, date of purchase, serial number and the nature of the failure. If the repair is not covered by the warranty, you will be notified of the charges incurred. If the instrument is to be returned to Hanna Instruments, first obtain a Returned Goods Authorization Number from the Customer Service department and then send it with shipment costs prepaid. When shipping any instrument, make sure it is properly packaged for complete protection.

TABLE OF CONTENTS

Preliminary Examination	3
General Description	5
Flow Rate Chart	7
Functional Description	9
Specifications	10
Valve / Hose Assembly Diagram	11
Installation	12
Operational Guide	21
Troubleshooting Guide	23
Maintenance	25
Chemical Compatibility Guide	27
Accessories	29
CE Declaration of Conformity	31

PRELIMINARY EXAMINATION

Remove the pump from the packing material and examine it carefully to make sure that no damage has occurred during shipping. If there is any noticeable damage, notify your Dealer.

Each pump is supplied complete with:

- 7 m (23') LDPE suction and discharge tubing
- Instruction manual

Note: Save all packing material until you are sure that the pump functions correctly. Any defective item must be returned in the original packaging together with the supplied accessories.

READ ATTENTIVELY THE INSTRUCTIONS BEFORE INSTALLING OR OPERATING YOUR PUMP

The BL electronic dosing pumps are easy to use. We recommend, however, that you read the entire manual before using the pump. Familiarity with the features and controls of the unit will give you a better idea of the dosing potential and help reduce operator errors. Please operate the pump only as directed in the instruction manual. Follow all general safety guidelines during operation. Remember: electrical devices are potentially hazardous. Check that the voltage of the installation matches the voltage indicated on the specification label on the back of the pump. Always be sure the pump is grounded.

Note: It is the responsibility of the user to install and ground the pump properly; it is highly recommended to install an external switch.

Always store chemicals in safe, out of reach places. Follow the directions for use with each chemical. Do not assume chemicals are the same because they look alike. Hanna Instruments cannot be held responsible for the misuse of chemicals or the pump.

Always wear protective clothing (gloves and safety glasses) when working near chemical dosing pumps. When pumping chemicals, make sure all tubes are securely attached to the fittings. It is recommended that tubing is shielded to prevent possible injury in case of rupture or accidental damage.

Avoid using a pipe wrench or pliers on plastic parts and connectors. These are best tightened with an open end or crescent wrench. Avoid overtightening these parts as this could cause damage to the seats and threads.

If a hose is used, it should be securely fastened to columns, walls, braces, etc. This will ensure that the hose connection will remain tight and leak free. Shield the hose from direct sunlight. Sunlight can cause an autocatalytic reaction with some chemicals and weaken the hose walls.

The arrow on the pump head indicates the direction of chemical flow and should always point upwards (vertically). Never position the pump horizontally with suction and discharge valves horizontal. Locate the pump in an area out of the reach of children and pets. All pumps undergo stringent tests to ensure that they comply with their stated specifications and are calibrated at the maximum rated pressure.

GENERAL DESCRIPTION

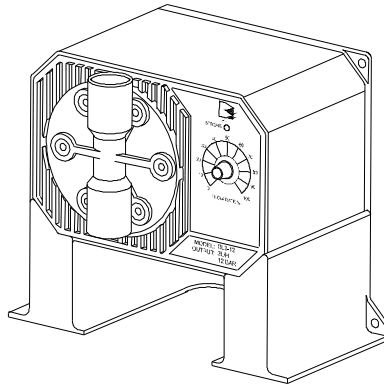

BlackStone pumps are equipped with a single control for pump output.

Flow range is continuously adjustable from 0 to 100% of the maximum capacity through a graded dial on the front of the pumps. Seven models are available, each with a different dosing capacity:

BL 20	18.3 lph (4.8 gph)	@ 0.5 bar (7.4 psi)
BL 15	15.2 lph (4.0 gph)	@ 1 bar (14.5 psi)
BL 10	10.8 lph (2.9 gph)	@ 3 bar (43.5 psi)
BL 7	7.6 lph (2.0 gph)	@ 3 bar (43.5 psi)
BL 5	5.0 lph (1.3 gph)	@ 7 bar (101.5 psi)
BL 3	2.9 lph (0.8 gph)	@ 8 bar (116 psi)
BL 1.5	1.5 lph (0.4 gph)	@ 13 bar (188.5 psi)

HIGH QUALITY MATERIALS

To provide the maximum protection for parts that are in contact with aggressive chemicals, diaphragms, hose connectors and pump heads are produced using materials as PVDF and PTFE. The ball valves are constructed in glass. The body is made of fiber-reinforced polypropylene for strength and durability.

RELIABILITY THROUGH SIMPLICITY

All BlackStone pumps use the positive displacement solenoid method of pumping. This method has fewer moving parts than a standard motor-driven pump, and does not have the mechanical failures associated with conventional pumps.

BlackStone's Positive Displacement design has several distinct advantages over other types of mechanical designs:

- It is more accurate. Each stroke of the piston is precisely the same as the stroke before it ... and the stroke after it.
- Positive displacement allows for easier self-priming.
- Pumping pressure is as high as 12 bar (176 psi). This allows you to install your pump in the widest variety of tank-to-tank and tank-to-in-line applications.
- High accuracy and repeatability. A wire-wound potentiometer and solid state electronics are combined to achieve greater precision and control.

EASY INSTALLATION

Designed with mounting holes in the base as well as rear panel, BlackStone pumps can be installed on a wall as well as directly on top of tanks and drums.

There is no need for additional hardware.

All the controls and pump assemblies are conveniently located on the front of the unit.

If the operator must access the pump head or control panel for any reason, there is no need to dismount the unit.

FLOW RATE CHART

The following charts show the relationship between their flow rate and pressure.

An increase of pressure in the system decreases the flow rate.

BL1.5	
bar (psi)	lph (gph)
0.5 (7.4)	8.3 (2.20)
1 (14.7)	6.8 (1.80)
2 (29.4)	5.4 (1.43)
3 (44.1)	5.2 (1.38)
4 (58.8)	4.8 (1.27)
5 (73.5)	4.5 (1.19)
6 (88.2)	4.1 (1.08)
7 (102.9)	3.2 (0.85)
8 (117.6)	2.9 (0.77)
9 (132.3)	2.1 (0.56)
10 (147)	1.8 (0.48)
11 (161.7)	1.7 (0.45)
12 (176.4)	1.6 (0.42)

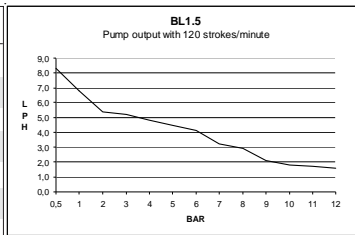

BL3	
bar (psi)	lph (gph)
0.5 (7.4)	15.8 (4.18)
1 (14.7)	12.2 (3.23)
2 (29.4)	9.3 (2.46)
3 (44.1)	7.9 (2.09)
4 (58.8)	6.5 (1.71)
5 (73.5)	5.0 (1.32)
6 (88.2)	4.0 (1.06)
7 (102.9)	3.3 (0.87)
8 (117.6)	2.9 (0.77)
9 (132.3)	2.5 (0.66)
10 (147)	2.2 (0.58)
11 (161.7)	1.9 (0.50)
12 (176.4)	1.5 (0.40)

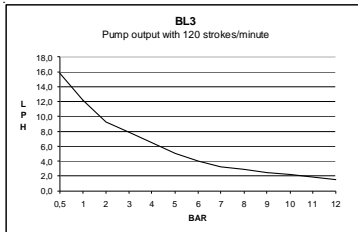

BL5	
bar (psi)	lph (gph)
0.5 (7.4)	15.8 (4.18)
1 (14.7)	12.2 (3.23)
2 (29.4)	10.8 (2.86)
3 (44.1)	9.3 (2.46)
4 (58.8)	7.9 (2.09)
5 (73.5)	6.5 (1.72)
6 (88.2)	5.8 (1.53)
7 (102.9)	5.0 (1.32)
8 (117.6)	4.3 (1.14)
9 (132.3)	4.0 (1.06)
10 (147)	3.6 (0.95)

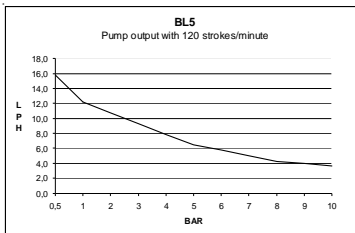

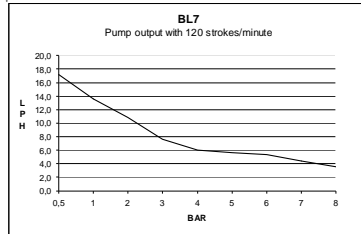

BL7	
bar (psi)	lph (gph)
0.5 (7.4)	17.2 (4.55)
1 (14.7)	13.6 (3.60)
2 (29.4)	10.8 (2.86)
3 (44.1)	7.6 (2.01)
4 (58.8)	6.0 (1.59)
5 (73.5)	5.7 (1.51)
6 (88.2)	5.4 (1.43)
7 (102.9)	4.4 (1.16)
8 (117.6)	3.6 (0.95)

BL10	
bar (psi)	lph (gph)
0.5 (7.4)	18.3 (4.84)
1 (14.7)	15.2 (4.02)
2 (29.4)	13.6 (3.60)
3 (44.1)	10.8 (2.86)
4 (58.8)	9.4 (2.49)

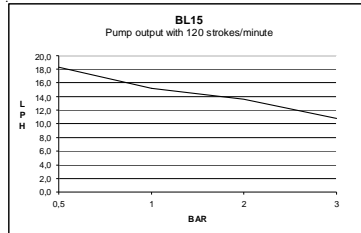
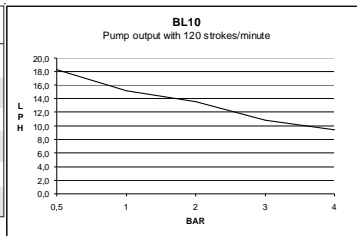

BL15	
bar (psi)	lph (gph)
0.5 (7.4)	18.3 (4.84)
1 (14.7)	15.2 (4.02)
2 (29.4)	13.6 (3.60)
3 (44.1)	10.8 (2.86)

BL20	
bar (psi)	lph (gph)
0.5 (7.4)	18.3 (4.84)
1 (14.7)	15.2 (4.02)
2 (29.4)	13.6 (3.60)

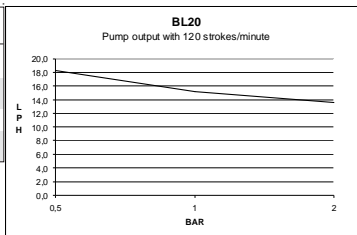

FUNCTIONAL DESCRIPTION

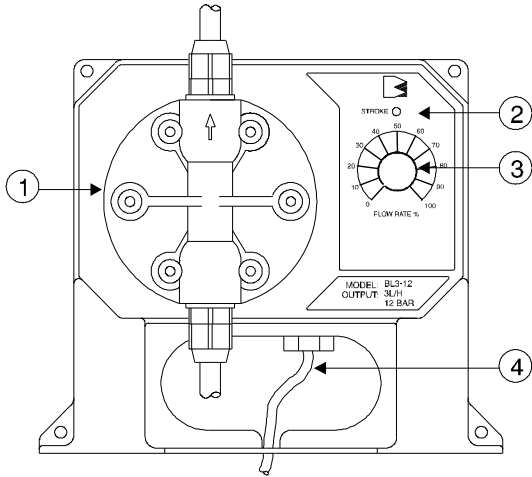

1. Pumphead
2. Stroke LED
3. Flow Rate % Knob
4. Power Cord

MECHANICAL DIMENSIONS

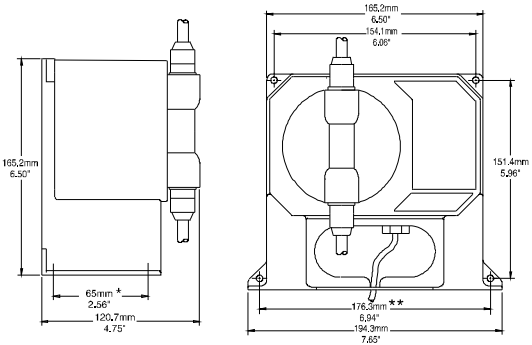

SPECIFICATIONS

MAX FLOW RATE	
BL1.5	1.5 lph (0.4 gph) @ 13 bar (188.5 psi)
BL3	2.9 lph (0.8 gph) @ 8 bar (116 psi)
BL 5	5.0 lph (1.3 gph) @ 7 bar (101.5 psi)
BL7	7.6 lph (2.0 gph) @ 3 bar (43.5 psi)
BL10	10.8 lph (2.9 gph) @ 3 bar (43.5 psi)
BL15	15.2 lph (4.0 gph) @ 1 bar (14.5 psi)
BL20	18.3 lph (4.8 gph) @ 0.5 bar (7.4 psi)
	Adjustable from 0 to 100% of maximum pump capacity
MATERIAL	
PUMP CASING	fiber-reinforced polypropylene
VALVES	glass balls + O-rings in FPM/FKM
PUMPHEAD	PVDF
DIAPHRAGM	PTFE
TUBING	polyethylene
SELF PRIMING	Max. height: 1.5 m (5')
POWER SUPPLY	
BL...-1	100/115 Vac; 50/60 Hz
BL...-2	220/240 Vac; 50/60 Hz
MAX POWER CONSUMPTION	200 W
PROTECTION	IP65
ENVIRONMENT	0 to 50°C (32 to 122°F) 95% RH max
DIMENSIONS	194 x 165 x 121 mm (WxHxD) (7.6 x 6.5 x 4.8")
WEIGHT	3 kg (6.6 lb.)

VALVE / HOSE ASSEMBLY DIAGRAM

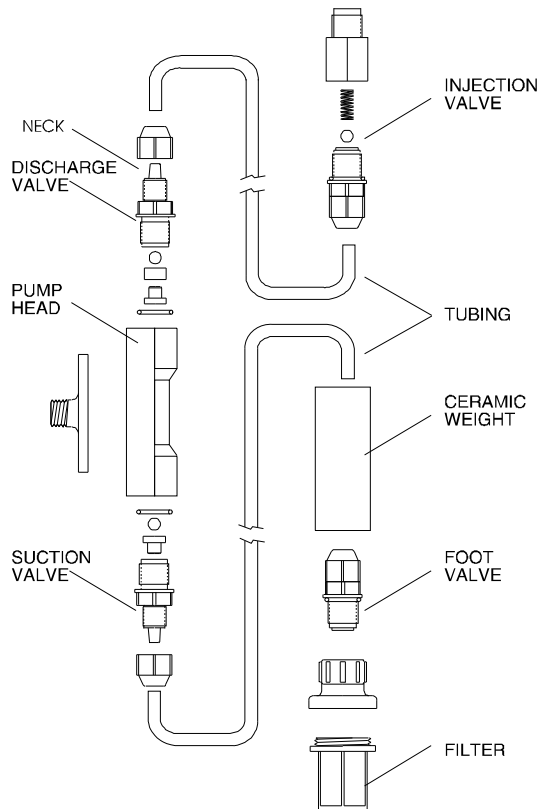

INSTALLATION

MATERIALS NEEDED

- LDPE hose (7 meter / 22 feet) (**included**) or other type of tubing (PTFE, for example) more suitable for a specific application (optional)

OPTIONAL ACCESSORIES

- 4 each, ceramic weights (HI 721008)

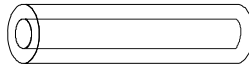

- 1 each, foot valve assembly (HI 721005)

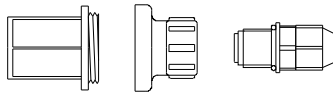

- 1 each, injection valve assembly (HI 721004)



LOCATION

A suitable location should:

- be near to a power source
- be conveniently close to the injection point
- allow easy access to the flow rate control and pipe or hose connections
- be no more than 1.5 meters (5 feet) above the operating position of the suction valve assembly.

DIMENSIONS FOR INSTALLATION

BlackStone pumps are designed for permanent installation. The pump can be mounted directly on a wall or tank.

POWER REQUIREMENTS

BlackStone pumps are designed to operate to specifications within the following voltage ranges:

100 - 130 Volts for -1 models

200 - 240 Volts for -2 models

To ensure maximum performance, check the voltage at the point of supply to verify that it is sufficient. It is recommended that you install a 1 Amp circuit breaker between the pump and the power supply. This will give additional protection to the internal circuit and provide a convenient way to disconnect the power supply prior to servicing the pump, if needed.

INJECTION POINT

- Choose an injection point that allows you to mount the injection valve assembly vertically.
- The spring in the injection valve assembly (HI 721004) adds approximately 1.5 bar of back pressure. If pumping into a high back pressure, the spring should be removed.

OTHER CONSIDERATIONS

- If you are mounting the system to a wall, column, etc., be sure it is strong enough to support the weight of the entire system.
- The ambient temperature of the pump, when in operation, should be between 0 and 50°C (32 to 122°F) and should be protected from direct exposure to outdoor elements (direct sunlight, rain, extreme temperatures, high humidity, etc.).
- Generally speaking, the shorter the suction distance, the more efficient the pump operates.
- The pump should be placed in a conventional location that will allow easy access to the control and connections. It should be placed so that regular visual inspections of the connections and hoses are facilitated.

VERTICAL SURFACE MOUNTING

Once you have selected the best installation site, simply screw or bolt the unit into a wall or mounting panel above the chemical feed tank.

The 4 mounting screw holes on the pump will accommodate up to a 5 mm (3/16") screw or bolt (remember to use heavy screws or bolts to secure the system).

Be sure you do not over tighten and cause excessive stress on the mounting holes.

ELECTRICAL CONNECTIONS

Note: All cables must be according to local electrical codes.

For safety of the users, the pump has to be grounded.

The pump should be connected to a single phase power source.

Color coding for wires:

Blue - Live

Brown - Neutral

Yellow/Green - Ground (earth)

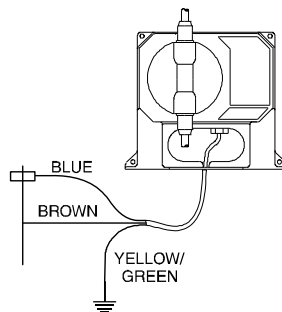

It is recommended that the system be connected to a power line/leg equipped with a circuit breaker of 1 Amp.

PERMANENT CONNECTION USING 3/8" PVC PIPE

All piping for the pump feed and discharge should be plumbed to the location of the pump.

The threads on both valve assemblies allow the use of standard 3/8" (European) pipe fittings for permanent pipe connections.

The foot valve assembly (HI 721005) should always hang vertically and not lay horizontal on the bottom of the tank or drum.

A vertical assembly will ensure that the valve is positioned properly and prevent loss of prime.

For the U.S. standard installations, use PVC adapters to connect the suction and discharge valves to the PVC pipe.

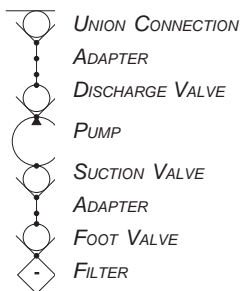
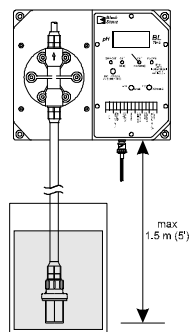
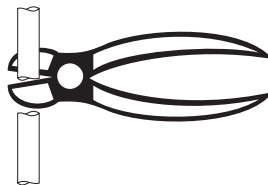

Diagram for Rigid Pipe Hose



HOSE CONNECTIONS

- Cut a long enough section of the hose to reach the suction valve of the pumphead from the feed tank. Allow some slack in the hose and be sure it is not kinked or twisted.



- Slip a hose connector onto the hose over the head valve and up to the bottom of the threads ensuring it is fully seated.
- Slide the connector up to the threads and tighten to form a seal.

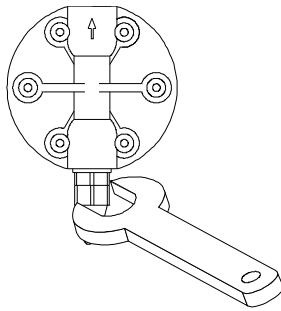
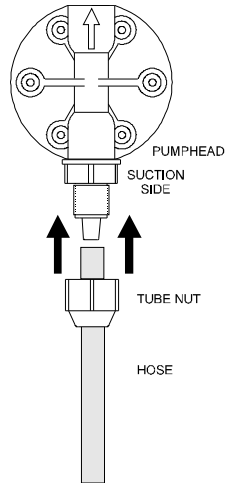

- Slip the ceramic weight (HI 721008) and a connector over the other end of the hose.
- Attach the foot valve assembly (HI 721005) to the hose and slide the connector up to the threads and tighten to form a seal.

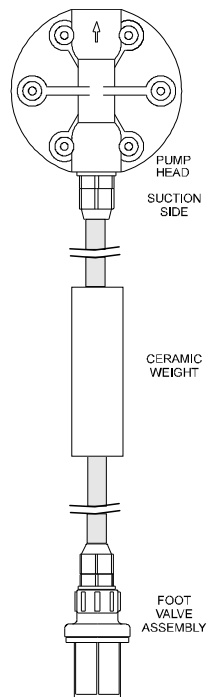

- Repeat the same installation procedure for the hose connections on the discharge end with the injection assembly (HI 721004).

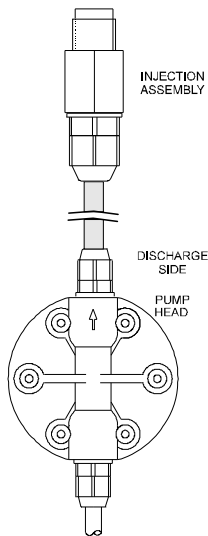
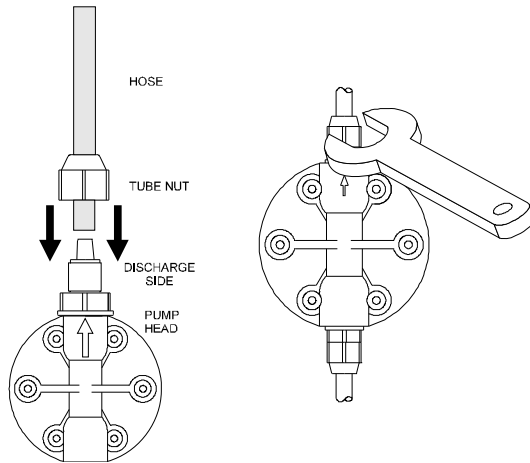

- Secure the hose so that its movement is minimized when the pump is operating. Excessive hose movement could cause the connectors to loosen and result in leakage.

ASSEMBLING THE HOSE TO THE VALVE

The end of the valve is specially tapered to form a leak free seal when the hose is properly installed.

Be sure to seat the hose completely so that there is no gap. Push the hose until it covers the end of the valve completely.

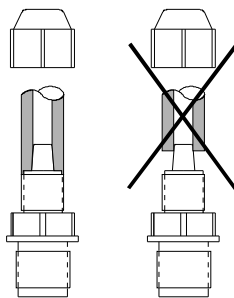

SUCTION AND DISCHARGE VALVES

The suction and discharge valves located on the pumphead should not be interchanged as they are different internally. The discharge valve is fitted with a valve guide and will not function properly if used on the suction side.

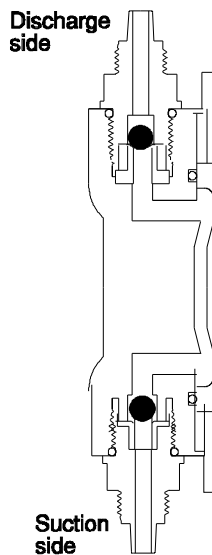

EXAMPLE OF TYPICAL INSTALLATIONS

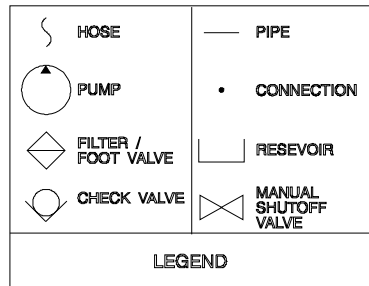

FLOODED SUCTION INSTALLATION

Suggested Installation for consistent output when using a low stroke rate. Also suggested for highly viscous chemicals.

A slight suction pressure avoids self-priming problems, especially with high viscosity liquids.

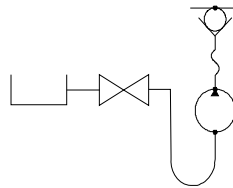

SUCTION LIFT INSTALLATION

Suggested installation for most in-line applications with nominal output and pressures.

The maximum self-priming height is 1.5 m (5 ft.). It is advisable to install a level controller in order to stop the pump when feed tank liquid level is low.

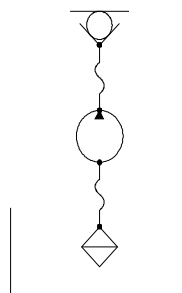

UPHILL INSTALLATION

Suggested installation whenever the supply is located higher than the discharge point; typically a waste water application.

It is important to install the Injection valve to prevent siphoning.

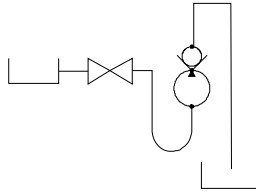

DOWNHILL INSTALLATION

Suggested installation when pumping from one container to another, each at different levels and with only nominal pressure.

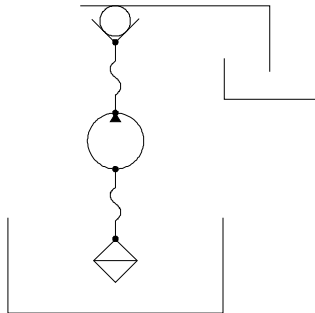

OPERATIONAL GUIDE

START-UP

At start-up, purge all chemical gases and air from the suction tubing, valves and pump head. Start the pump.

When all the air or gas is vented, the solution being metered will appear in the output line.

Note: Only when operating under pressure, the pump must be started unloaded.

An external Flow Rate Control (potentiometer) on the face of the pump allows to adjust the flow up to 100% of the pump's rated capacity.

A LED indicator will light up each time a stroke begins.

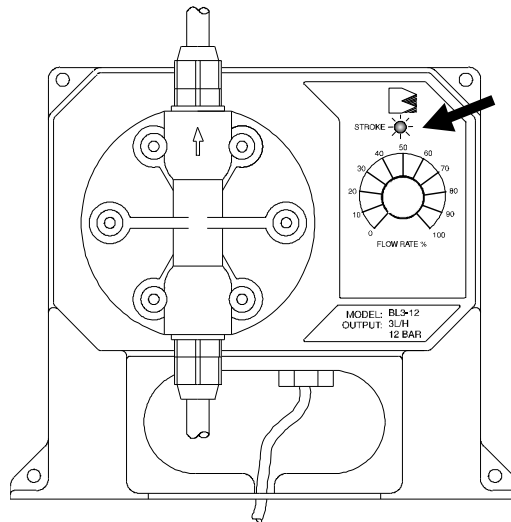
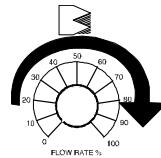

OPERATING PRESSURE AND BACK PRESSURE

Operating pressure is a combination of back pressure plus all of the other resistances to flow present in your system.

BlackStone Pumps are designed to dose their rated output at the operating (*rated*) pressure.

Therefore, *rated* pressure of the pump you install should be close to operating pressure present in the system.

Too little back pressure can cause the pump to overdose.

To prevent this from happening on a low back pressure installation, a spring has been added to the discharge/anti-siphon valve assembly (HI 721004).

When pumping into a high back pressure, the spring should be removed.

ACTUAL FLOW RATE

The actual flow rate depends upon the operating pressure which includes resistance at the injection fittings, hose and piping, the chemical viscosity and suction lift. The Flow Rate Control adjusts the flow up to 100% of the *rated* output. Less back pressure will increase the output, more will decrease it. To determine the correct setting for your application, use the following procedure.

1. Be sure that the pump is primed and that the output connections are completed at the injection point.
2. Place the foot valve assembly (HI 721005) in a graduated container with 500 mL of the solution to be dosed.
3. Switch the pump from OFF to the 100% setting and run until the system has been fully reprimed. Switch OFF and refill the container to the 500 mL level.

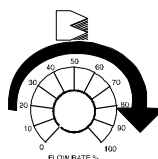
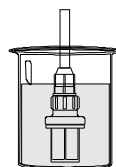

4. Switch the pump ON to the estimated setting and run for a specific amount of time (e.g. 1 minute). Count the number of strokes, length of time, and volume pumped.

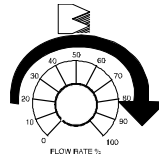

Note: It is suggested that you run the test for as long as possible to maximize the accuracy.

For example, if at the maximum setting of 100% you find you pumped 200 mL in one minute, your hourly output would be 12 liters/hour (200 mL x 60 min. = 12000 mL/hr). If your application called for 9 liters/hour, turn the Flow Rate Control to 7 (9/12). Run the test again to verify the results.

TROUBLESHOOTING GUIDE

ELECTRICAL

The pump does not operate when turned ON:

- Check the power supply and connections. Voltage should be between 100 - 130 Vac for -1 models and between 200 - 240 Vac for -2 models.
- Check wiring color scheme. See Installation section or call for technical assistance.

LIQUID

The pump operates but does not prime:

- Check for a clogged or loose filter on the suction valve assembly. Retighten if necessary.
- Check to see if the pump is too high above the foot valve assembly (**HI 721005**) in the feed tank. This vertical distance should not exceed 1.5 meters (5 feet). Either lower the pump or raise the feed tank.
- Check the pumphead, suction and discharge valves for blockage.

Pump flow rate is reduced:

- Check the pumphead, discharge and injection valve assembly for any clogging. Clean and reassemble.
- Check for any additional back pressure created since the last flow rate was conducted.
- Check for any changes in the viscosity of the chemicals being used. Increase the % flow by adjusting the Flow Rate control to a higher setting and run a Flow Rate test.
- Be sure that valves have been properly installed in the pumphead.

Leakage at the connections:

- Be sure that the hose is fully seated and hose connectors are tight.
- Be sure that valves are tight and O-rings are in place.

Leakage around the pumphead:

- Be sure that the valves are tight and O-rings are in place and the head screws (hex bolts) are tight.

MAINTENANCE

Your BlackStone Pump is designed to give you years of trouble-free service. Maintenance should be the preventative type, that is, periodic cleaning and inspecting for any damage or leakage.

CLEANING THE SUCTION, DISCHARGE AND INJECTION VALVES

Remove the valves from the pumphead, the injection fitting and the feed.

Keep the suction and discharge valves separated as they are not interchangeable.

Disassemble each valve and clean it with a neutral liquid. Inspect the PVDF springs.

After cleaning the glass balls, inspect them for any excessive wear due to abrasion from the chemical. Replace if necessary with parts from **HI 721102**, **HI 721103**, **HI 721104** and **HI 721105**.

When reinstalling the valves into the pumphead, tighten by hand first and then with a wrench $\frac{1}{4}$ to $\frac{1}{2}$ turn.

INSPECTING THE HOSE (if used as supplied with the pump)

Inspect to see if the hose has worn out or weakened due to the chemicals. Pay particular attention for any signs of abrasion or discoloration. Also check the connectors to ensure they are tight. Replace if necessary with parts from **HI 720032**.

CLEANING THE PUMPHEAD

The pumphead should be cleaned at regular intervals and at least once a year. Remove the deposits that form in the cavities with a solution that is neutral to the chemical the pump has been dosing. Inspect the head for any cracks or worn areas.

Replace if necessary with parts from the pumphead spare part **HI 721106** (for BL7, BL10, BL15 and BL20) or **HI 721107** (for BL1.5, BL3 and BL5).

SCHEDULED MAINTENANCE

After 50 hours

Tight the pumphead screws with a torque force of 2.5 Nm (22" lbf).

After 12 months

It is recommended to replace **HI 721102**, **HI 721103** (suction and discharge valves assemblies) as well as the O-rings. The LDPE hose can also deteriorate over time and, for safety reasons, should also be changed with **HI 720032**.

After 24 months

It is recommended to replace **HI 721102**, **HI 721103**, **HI 720032** and **HI 721106** (for BL7, BL10, BL15 and BL20) or **HI 721107** (for BL1.5, BL3 and BL5).

CHEMICAL COMPATIBILITY GUIDE

Partial Listing of Chemicals that can be used with BlackStone

Pumps

(Rated for 45°C. For higher temperatures consult your dealer or nearest Hanna Service Center.)

Adipic Acid	Caustic Soda
Alcohol Amyl	Chloral Hydrate
Alcohol, Diacetone	Chromic Acid 50%
Alcohol, Isopropyl	Citric Acid
Alcohol, Methyl	Copper Chloride
Aluminium, Ammonium Sulfate	Copper Cyanide
Aluminium Chloride	Copper Nitrate
Aluminium Sulfate	Copper Sulfate
Alums	Corn Oil
Ammonium Carbonate	Cottonseed Oil
Ammonium Chloride	Cresylic Acid
Ammonium Fluoride	Crude Oil
Ammonium Hydroxide	Dextrose
Ammonium Nitrate	Detergents (general)
Ammonium Phosphate	Diesel Fuel
Ammonium Sulfate	Diethyl Phthalate
Aqua Ammonia	Disodium Phosphate
Arsenic Acid	Ethanol (1-95%)
Barium Carbonate	Ethylene Dichloride
Barium Chloride	Ethylene Glycol
Barium Hydroxide	Fatty Acids
Barium Sulfate	Ferric Chloride
Beer	Ferric Nitrate
Beet Sugar Liquors	Ferric Sulfate
Bismuth Carbonate	Ferrous Chloride
Black Liquor	Ferrous Sulfate
Bleach	Fluoboric Acid
Borax	Fluosilicic Acid
Boric Acid	Formaldehyde
Bromic Acid	Fruit Juice Pulp
Butyric Acid	Fuel Oil
Calcium Bisulfite	Gallic Acid
Calcium Carbonate	Gasoline, Refined
Calcium Chlorate	Glucose
Calcium Chloride	Glycerine or Glycerol
Calcium Hydroxide	Glycolic Acid 30%
Calcium	Hexane
Hypochlorite	Hydrazine
Calcium Nitrate	Hydrobromic Acid 20%
Calcium Sulfate	Hydrochloric Acid (Concentrated)
Carbonic Acid	Hydrochloric Acid (Diluted)
Castor Oil	Hydrogen Sulfide Aqueous Solution

Hypochlorous Acid	Propylene Dichloride
Kerosene	Sea Water
Lactic Acid	Silver Nitrate
Lard Oil	Silver Plating Solutions
Lauric Acid	Soaps
Lead Acetate	Sodium Acetate
Linoleic Acid	Sodium Bicarbonate
Linseed Oil	Sodium Bisulfate
Lithium Salts	Sodium Bisulfite
Magnesium Carbonate	Sodium Borate
Magnesium Chloride	Sodium Chlorate
Magnesium Hydroxide	Sodium Chloride
Magnesium Nitrate	Sodium Cyanide
Magnesium Oxide	Sodium Fluoride
Magnesium Sulfate	Sodium
Maleic Acid	Hexametaphosphate
Malic Acid	Sodium Hydroxide 50%
Mercuric Chloride	Sodium Hypochlorite 18%
Methanol	Sodium Metaphosphate
Methyl Sulfate	Sodium Nitrate
Milk	Sodium Peroxide
Mineral Oils	Sodium Phosphate
Naptha Petroleum	Sodium Silicate
Nickel Chloride	Sodium Sulfate
Nickel Sulfate	Sodium Sulfide
Nitric Acid 50%	Sodium Sulfite
Oils and Fats	Sodium Thiosulfate
Oleic Acid	Sour Crude Oil
Olive Oil	Stannic Chloride
Oxalic Acid	Stannous Chloride
Palmitric Acid	Stearic Acid
Perchloric Acid 70%	Sulfur
Perchloroethylene	Sulfuric Acid Concentration
Petroleum Oils (sour)	Sulfurous Acid
Phenol	Tannic Acid
Phosphoric Acid	Tanning Liquors
Photographic Solutions	Tartaric Acid
Plating Solutions	Tetrachlorethane
Potassium Carbonate	Tetraethyl Lead
Potassium Bromide	Tetralin
Potassium Chlorate	Tin Salts
Potassium Chloride	Vegetable Oils
Potassium Cyanide	Vinegar
Potassium Ferrocyanide	Water Acid, Mine
Potassium Hydroxide	Water, Fresh
Potassium Nitrate	Water, Distilled
Potassium Permanganate 10%	Water, Salt
Potassium Phosphate	Whiskey
Potassium Sulfate	Wines
Propyl Alcohol	Zinc Chloride
	Zinc Sulfate

ACCESSORIES

SPARE PARTS

HI 721102 Discharge Valve
(Glass Ball, Valve O-Ring, Hose Connector)

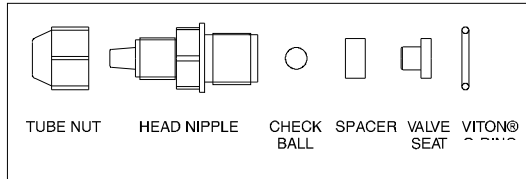

HI 721103 Suction Valve (Glass Ball, Valve O-Ring, Hose Connector)

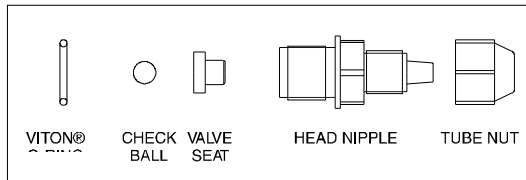

HI 721003 10 x Glass Balls
10 x Valve O-Rings

HI 721004 Injection Valve Assembly

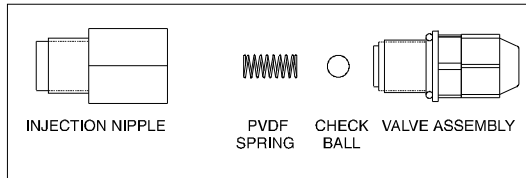

HI 721005 Foot Valve Assembly

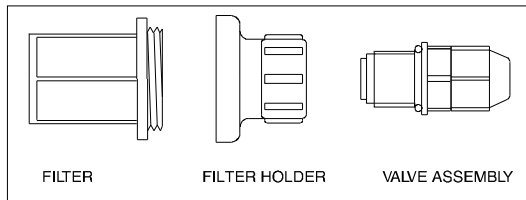

HI 721006 PVDF Springs, 4 pcs

HI 720032 LDPE Hose - 100 m (330')

HI 721008 Ceramic Weights, 4 pcs

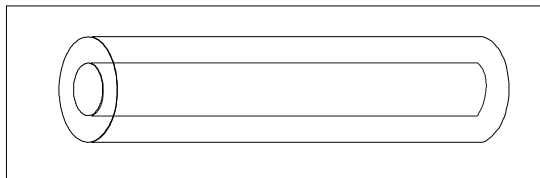

HI 721101 Pumphead, O-Ring, 6 screws and washers

HI 721106 (for BL7, BL10, BL15 and BL20)

Pumphead
Large PTFE Diaphragm
Aluminum Piston
Aluminum Disk

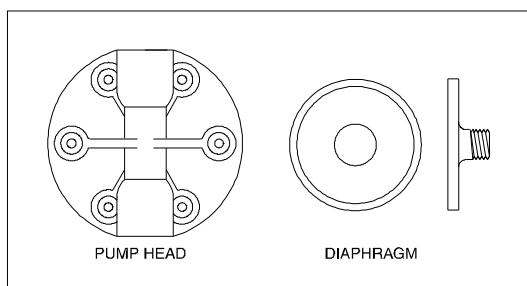

HI 721107 (for BL1.5, BL3 and BL5)

Pump-head
Small PTFE Diaphragm
Aluminum Piston

OTHER ACCESSORIES

HI 731326 Calibration screwdriver (20 pcs)

CE DECLARATION OF CONFORMITY



DECLARATION OF CONFORMITY

We

Hanna Instruments Italia Srl
via E. Fermi, 10
35030 Sarmeola di Rubano - PD
ITALY

herewith certify that the dosing pumps

BL 1.5 BL 3 BL 5 BL 7 BL 10
BL15 BL 20 BL 7913 BL 7914

have been tested and found to be in compliance with EMC Directive 89/336/EEC and Low Voltage Directive 73/23/EEC according to the following applicable normatives:

EN 50082-1: Electromagnetic Compatibility - Generic Immunity Standard
IEC 801-2 Electrostatic Discharge
IEC 801-3 RF Radiated
IEC 801-4 Fast Transient

EN 50081-1: Electromagnetic Compatibility - Generic Emission Standard
EN 55011 Radiated, Class B

EN61010-1: Safety requirements for electrical equipment for measurement, control and laboratory use

Date of Issue: 2-12-1998

P. Cesa - Technical Director

On behalf of
Hanna Instruments S.r.l.

RECOMMENDATIONS FOR USERS

Before using these products, make sure that they are entirely suitable for the environment in which they are used.

Operation of these instruments in residential area could cause unacceptable interferences to radio and TV equipments, requiring the operator to take all necessary steps to correct interferences.

Any variation introduced by the user to the supplied equipment may degrade the instruments' EMC performance.

Hanna Instruments reserves the right to modify the design, construction and appearance of its products without advance notice.



Hanna Instruments Inc.
Highland Industrial Park
584 Park East Drive
Woonsocket, RI 02895 USA

Technical Support for Customers
Tel. (800) 426 6287
Fax (401) 765 7575
E-mail tech@hannainst.com
www.hannainst.com

Local Sales and Customer Service Office

